



**16mm Metal Shaft Rotary Potentiometer (16mm 金屬軸旋轉電位器)**



**Part Number**

**R16K1 - B 10K, L - 20 KC**

↓ Taper 線性    ↓ Resistance Value 阻值    ↓ Shaft Type 軸型  
 Shaft Length 軸長

**Dimensions 規格尺寸**

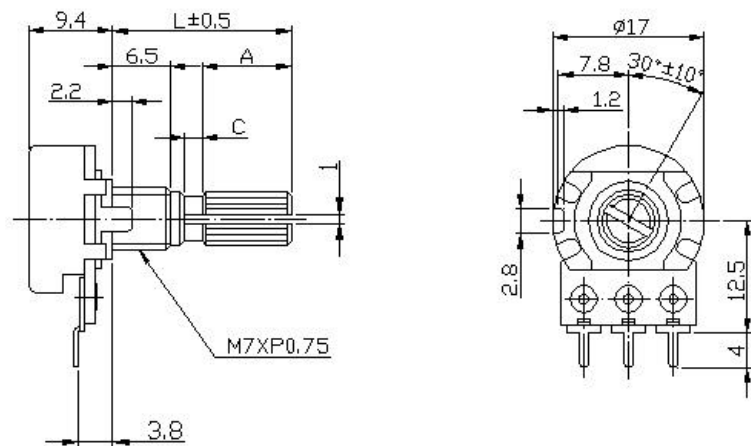

**Shaft Type 軸型**

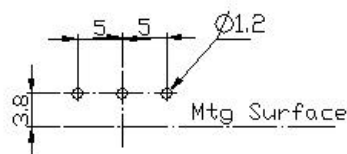

**CIRCUIT**

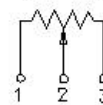

**KC TYPE**

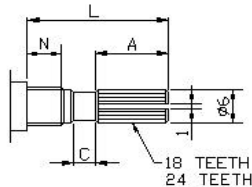

**RE TYPE**

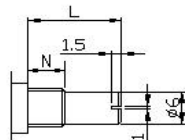

**R TYPE**

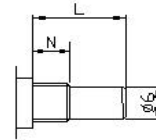

**F TYPE**

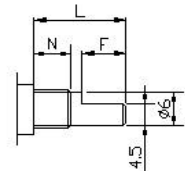

Ni6.5m/m

SHAFT-TYPE	L	10	15	20	25	30	35	40
KC	A	2.2	6	10	12	12	12	12
	C	0.5	1	2	2	4	4	4
F	F	2.5	7	12	12	12	12	12
R,RE	L	10	15	20	25	30	35	40



**16mm Metal Shaft Rotary Potentiometer (16mm 金屬軸旋轉電位器)**

**Electrical Characteristics 電氣特性**

Total Resistance 總阻值	500 ~ 2M				
Total Resistance Tolerance 總阻值誤差	± 20% (More than 1M ± 30%)				
Resistance Taper 線性	A. B. C. D. W. Taper				
Resistance Taper Characteristics 阻值變化特性範圍	A50%	B50%	C50%	D50%	W50%
	15-25%	40-60%	75-85%	2-15%	45-55%
Rated Power 定格電力	B Taper: 0.2 W; Other Tapers: 0.1 W				
Max. Operating Voltage 最高使用電壓	B Taper: AC150V; Other Tapers: AC200V				
Residual Resistance 殘留阻值	R <sup>3</sup> 250K 0.1%				
	250K > R > 10K	10 Max. ( between Term. 1, 2)			
	10K <sup>3</sup> R	10 Max. ( between Term. 2, 3)			
Noise 雜音	47 mV max.				
Insulation Resistance 絕緣阻抗	DC 500V 100M				
Withstand Voltage 耐電壓	1 minute AC 500V				
Rotational Life 旋轉壽命	15,000 Cycles				
Switch Life 開關壽命	10,000 Cycles				

**Mechanical Characteristics 機械特性**

Total Rotational Angle 全迴轉角度	300° ± 5°
Rotational Torque 迴轉扭力	30~200gf.cm
Pull-Push Strength 推拉強度	7 kgf.cm max./3 minute.
Center Click Torque C.C. 扭力	150~350g.cm
Click Position C.C 位置	Center 11/21/31/41 Detents
Solder Heat Resistance 鐔錫耐熱性	300 ,3s (Only For Hand-Soldering)
Remark 備註	Shaft: Cast Iron (Aluminum Zinc)
	Bushing Material: cast iron